

Electric Diaphragm Pump

Dimensions and Weights

ABEL-EM	Model	15	20	25	40	50	80	100
Flow	max. [m³/h]	1,25*)	2,5	5*)	10*)	18	40	60
Stroke rate	max. [1/min]	150	135	120	110	100	80	70
Motor size	max. [kW]	0,37	0,75	1,5	3,0	5,5	7,5	11,0
Suction connection		G ¾"	G 1"	G 1 ½"	G 2"	DN 80**)	DN 100	DN 100
Discharge connection		G ½"	G ¾"	G 1"	G 1 ½"	DN 50**)	DN 80	DN 150

Metal

a	360	450	540	610	840	1245	1666	a
b	260	330	400	520	779	956	1285	b
c	700	810	1000	1170	1360	1700	1920	c
d	24	30	43	70	115	116	152	d
e	230	290	360	470	696	861	1175	e
f	280	330	410	440	585	775	860	f
g	175	175	280	240	330	450	450	g
h	300	380	450	510	645	985	1356	h
i	80	100	135	165	260	210	250	i
k	30	30	40	56	100	125	180	k
l	68	88	108	133	168	220	270	l
Weight approx [kg]	35	65	120	160	365	875	1500	

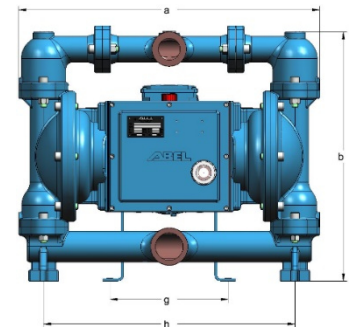
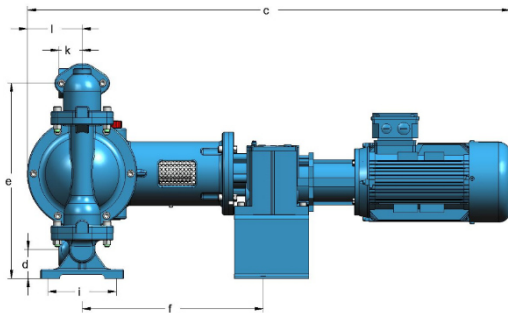

Plastic	15	20	25	40	50	80	100
a	410	510	600	680	890	-----	-----
b	270	320	400	495	764	-----	-----
c	710	820	1010	1190	1400	-----	-----
d	41	35	55	65	125	-----	-----
e	240	280	360	440	675	-----	-----
f	280	330	408	460	585	-----	-----
g	175	175	280	240	330	-----	-----
h	300	380	460	520	645	-----	-----
i	60	80	190	243	300	-----	-----
k	30	38	48	55	73	-----	-----
l	80	98	120	146	211	-----	-----
Weight approx [kg]	40	60	110	140	330	-----	-----

*) approx 50% with PTFE diaphragms **) in Plastic G 3"/G 2"

